

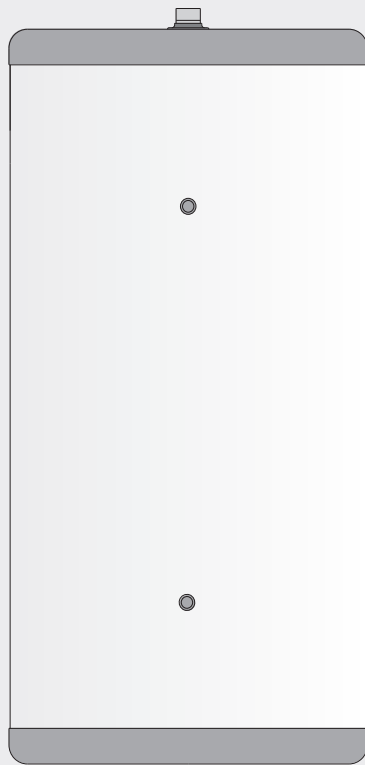

PAW-BTANKG200L  
PAW-BTANKG260L



***Technical Data Manual***

## Table of contents

Important information 	2
Drawing	3
Technical data	3
ErP data	3
Components	4
Transport and package	4
Area and placement of the tank	4
Before installation Heating and Hot water	4
Installation, Schematic example	5
Installation, General norms	5
Spare parts	6
Warranty and product liability	8

## Important information



In order to avoid hazards, please read the installation manual carefully before beginning installation. Incorrect repairs may lead to danger to users. Only trained and qualified technicians are authorized to install, move, modify or repair this product. If these regulations are not complied with, visits from an authorized service technician to carry out adjustments or repairs may be charged, even during the warranty period. The warranty does not apply if the applicable regulations are not complied with. Persons with learning difficulties or disabilities may not use the unit unless they have been instructed in how to use it in a safe way. Children must not be allowed to play with the equipment. Keep an eye on them! The tank must not be stored outdoors before installation. Always wear gloves during installation or repair. Touching the pipes may lead to hot or cold burns. Means of disconnection must be supplied for the fixed installation, in accordance with the installation norms.

# PAW-BTANKG200/260L

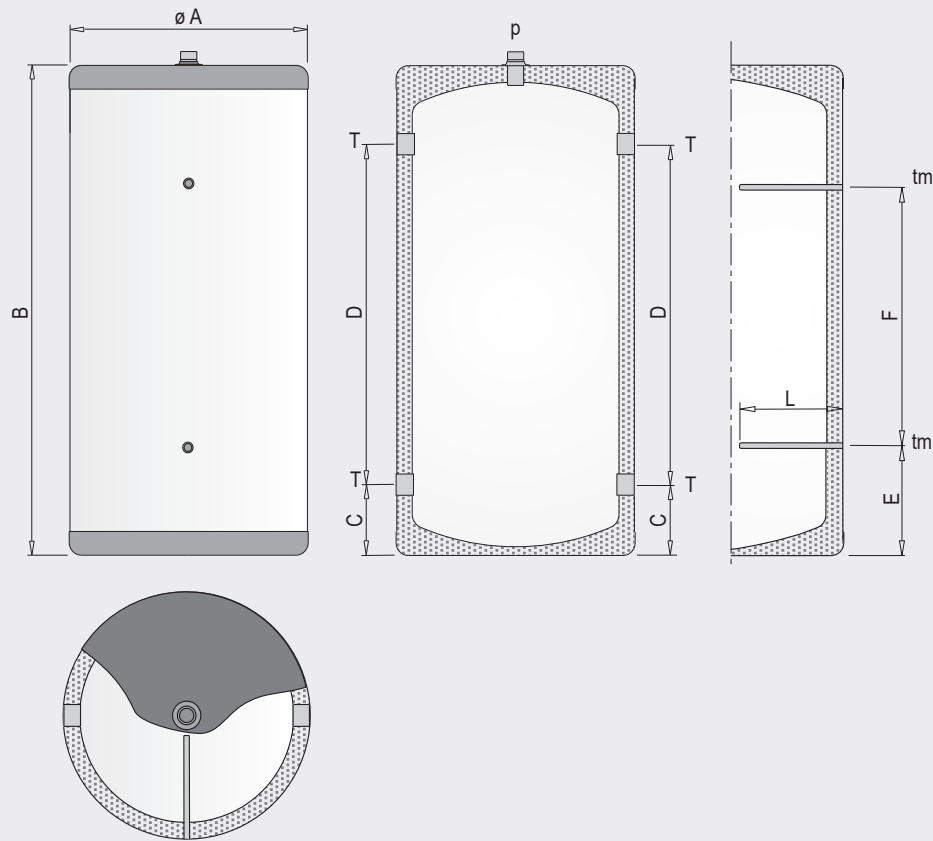

## Technical data

		PAW-BTANKG200L	PAW-BTANKG260L
Capacity	l	194	252
Max. working temperature	°C	100	100
Max. working pressure	MPa (bar)	0.6 (6)	0.6 (6)
Weight	Kg	41	46
T: connection	"G/F	1-1/2	1-1/2
tm: probe tube for sensors	øint (mm.)	10	10
p: Purge	"G/M	1	1
Dimension A: External diameter	mm	620	620
Dimension B: Overall height	mm	983	1293
Dimension C:	mm	168	168
Dimension D:	mm	624	873
Dimension E:	mm	194	279
Dimension F:	mm	566	652
Dimension L:	mm	285	285

## Erp data

		PAW-BTANKG200L	PAW-BTANKG260L
Energy efficiency class (A+...F-)		B	C
Standing loss	W	60	83
Storage volume	lit.	194	252

## Components

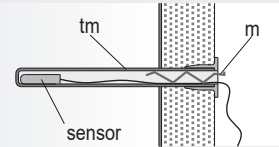
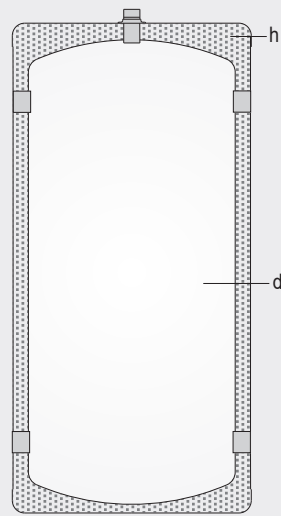
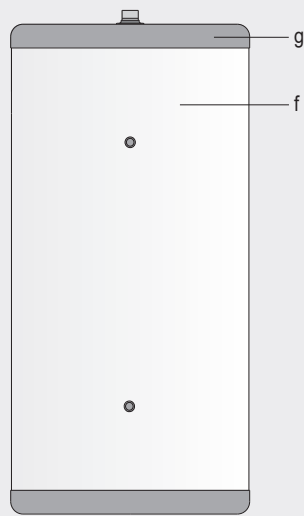

- d - Buffer tank
- f - External lining
- g - Upper cover
- h - Thermal insulation
- i - Air vent
- j - Adapter
- k - Metallic plug
- m - Clamping plate

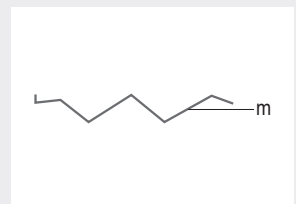
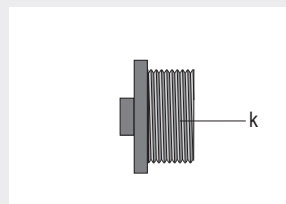
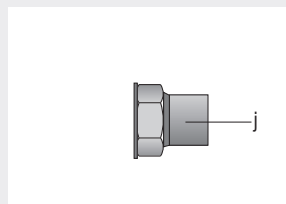
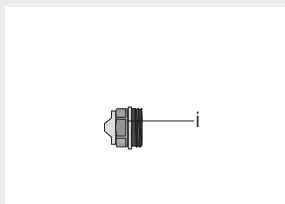

## Transport and package

Be careful during transportation of the tank unit.

- The tank unit is very heavy. Don't try to lift it alone!
- To avoid injuring your hands, wear gloves when moving the tank or removing the packaging.
- Be careful not to damage the tank unit when you remove the packaging.
- To avoid damage, drain the installed tank before moving.

## Area and placement of the tank

- The surrounding space must be dry, clean, free of vapor, volatile oils, smoke and gasses or the capacity may decrease considerably and internal parts may be damaged.
- The tank unit must be installed on a firm surface that tolerates its weight.
- The space must have a floor drain.
- The tank unit must be installed according to the instructions in order to reduce the risk of damage related to earthquakes, typhoons and storms.

## Before installation Heating and Hot water



### USEFUL HINTS

- To avoid particle filter and tank from becoming clogged, the existing heating system must be thoroughly cleaned before pipes are connected and water filled in the tank.
- Only use clean water in the tank. If the water quality is poor the tank may be damaged.

### Schematic example:

- 1 - Buffer tank
- 2 - Air vent
- 3 - Heat pump

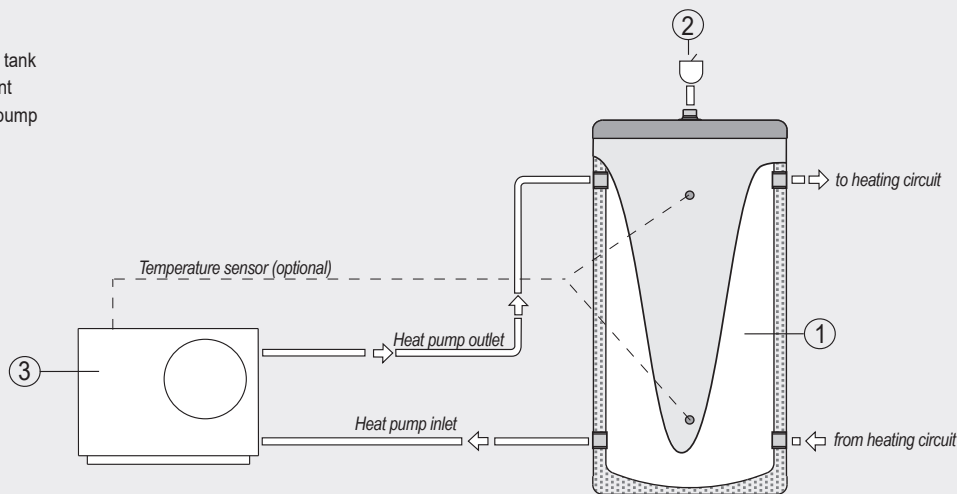

### GENERAL INSTRUCTIONS:







- The safety system should be included directly in to the water installation.
- In scenarios where only two of the T connections are needed, the remaining will be shut with the included metallic plugs.
- Measuring and control sensors must reach the end of the "tm" probe tube, assuring direct contact. The included clamping plate will lock up the sensor.
- Air vent will be installed in the "p" connection (1" G/M) using the 1" to ½" adapter included.
- A pressure-limiting device must be fitted in the installation. The rated pressure of the safety valve will be < 0.6 MPa (6 bar).
- Screw adjusted safety valves are prohibited in the installation.
- It is normal for water to be discharged during heating (expansion). The volume discharged may be up to 3% of the capacity of the storage tank.
- Purge circuits air once they have been filled with water
- In compliance with UNE-112076, a water meter will measure the volume of water used to refill the closed primary circuit, assuring that, annually, it will not exceed a 10% of the circuit's volume.
- Emptying of tank: Shut off the isolating valves and introduce a hosepipe through one of the lower T connections. Use a hydraulic pump to empty the tank through the hosepipe. Top connection must be free in order to maintain atmospheric pressure inside the tank through the process.
- The tank has two connections for measuring and control elements. Installer must decide which one to use depending on its purpose.

### PRECAUTIONS:

- Installation must be carried out by qualified personnel.
- This device is not designed for usage by any person (children included) whose mental or sensorial abilities are anyhow diminished, neither by whom have not enough experience or knowledge to use it. Children should be supervised and not allowed to play with this device.
- Install the tank in a place protected from ice and inclement weather.
- When replacing components, original spare parts must be used.
- Any failure in the installation may cause damages and risks.
- If it is the case, it is important to disconnect the tank from the mains water supply after filling before carrying out any operation.
- Risk of corrosion: the tank is made of carbon steel and thus, re-oxygenation of the CLOSED primary circuit is not permitted.
- The use of automatic filling valves in closed primary heating circuits is not recommended as re-oxygenation may occur inside the circuit.
- In combined systems, those parts of the installation that may provide oxygen must be physically isolated from the primary circuit, or materials that prevent this from occurring must be used (for example in houses with radiant floor heating or in the case of swimming pool heating).
- Do not install the tank in rooms intended for habitation (bedrooms, living rooms, etc.).
- The tank must be placed in a stable place with enough space to allow proper handling and maintenance. A minimum of 10 cm free space in the frontal and upper directions is recommended.
- The tank is suitable for operation in both heating and cooling applications.
- Tanks are manufactured to operate with drinking water of characteristics (conductivity, chemical composition, etc.) within the limits legally established according to European Directive 98/83/CE, with additional clauses and exceptions mentioned in the warranty conditions listed in the instruction manuals.

# PAW-BTANKG200/260L

## Spare parts

Part (picture)	Art-no	Name
	G005237	External lining 200
	G004681	External lining 260
	G000467	Upper cover
 <p>Clamping plate</p>	8430352026953	2 x Metallic plug 2 x Clamping plate
 <p>Metallic plug</p>		
 <p>Air vent</p>	8430352026960	1 x Air vent 1 x Adapter
 <p>Adapter</p>		



## Warranty and product liability

For product warranty to apply, the installation must be performed by an authorized technician

Connection of plumbing shall be carried in a safe manner resulting judgment laws and regulations available in the sector. It is very important to follow these instructions (including other parts of the heating system) and to carry out the maintenance provided. By following the installation instructions and design facility in relation to the housing needs, the system takes the premise to operating in many years to come.

In the event of failure of the system, notify your dealer immediately to document the case in accordance with the complaint- and quality routine available.

### VERY IMPORTANT



"Poor power" for example, from solar cells can damage a steel cylinder in a very short time, if it is passed in through the house's main electricity supply and through the pipeline system.

The Electrician need to verify that you have a "clean current supply" in the house.

If this mentioned procedures are not followed, the warranty may be voided.